

4237 EG Fireplace

Owner's Manual



⚠ WARNING:

If the information in these instructions is not followed exactly, a fire or explosion may result causing property damage, personal injury, or loss of life.

- Do not store or use gasoline or other flammable vapors and liquids in the vicinity of this or any other appliance.
- **WHAT TO DO IF YOU SMELL GAS**
 - Do not try to light any appliance.
 - Do not touch any electrical switch; do not use any phone in your building.
 - Immediately call your gas supplier from a neighbor's phone. Follow the gas supplier's instructions.
 - If you cannot reach your gas supplier, call the fire department.
- Installation and service must be performed by a qualified installer, service agency, or the gas supplier.

! DANGER



**HOT GLASS WILL CAUSE
BURNS**

**DO NOT TOUCH GLASS
UNTIL COOLED**

**NEVER ALLOW CHILDREN
TO TOUCH GLASS**

A barrier designed to reduce the risk of burns from the hot viewing glass is provided with this appliance and shall be installed for the protection of children and other at-risk individuals.



Listed by
Omni-Test Laboratories, Inc.
Report # 0028GF104S
ANSI Z21.88:19
CSA 2.33:19
CSA 2.17-2017

- **Operation**
- **Maintenance**

This appliance may be installed in an aftermarket, permanently located, manufactured home (USA only) or mobile home, where not prohibited by local codes.

This appliance is only for use with the type of gas indicated on the rating plate. A conversion kit is supplied with the appliance.

INSTALLER: Leave this manual with the appliance.

French language manuals at fireplacex.com

CONSUMER: Retain this manual for future reference.

Manuels de langue Française à fireplacex.com

Introduction

We welcome you as a new owner of a 4237 EG gas fireplace. This manual details the operation and maintenance of this fireplace. Please familiarize yourself with the Owner's Manual before operating your heater and save the manual for future reference.

Important Information

No other 4237 EG gas fireplace has the same serial number as yours. The serial number is on the listing label that is chained to the gas control valve. This serial number may be needed in case you require service.

Model: 4237 EG Fireplace

Serial Number: _____

Purchase Date: _____

Purchased From: _____

Register your warranty online at:

traviswarranty.com

Save Your Bill of Sale.

To receive full warranty coverage, you will need to show evidence of the date you purchased your heater.

We suggest that you attach your Bill of Sale to this page so that you will have all the information you need in one place should the need for service or information occur.

Installation Warnings

- Installation requirements are printed in the 4237 Installation Manual (part # 100-01406). All requirements in the installation manual must be met.
- Failure to follow all of the requirements may result in property damage, bodily injury, or even death.
- This heater must be installed by a qualified installer who has gone through a training program for the installation of direct vent gas appliances.
- This appliance must be installed in accordance with all local codes if any; if not, follow ANSI Z223.1 and NFPA 54(88). In Australia follow AS/NZS 5601.1.
- In Manufactured or Mobile Homes must conform with Manufactured Home Construction and Safety Standard, Title 24 CFR, Part 3280, or, when such a standard is not applicable, the Standard for Manufactured Home Installations, ANSI/NCSCS A225.1. This appliance may be installed in Manufactured Housing only after the home is site located.
- The fireplace is designed to operate on natural gas, or propane (LP).
- All exhaust gases must be vented outside the structure of the living area. Combustion air is drawn from outside the living-area structure.
- Notify your insurance company before hooking up this fireplace.

Table of Contents

Introduction	2	Display Fahrenheit or Celsius	15
Important Information	2	Low Battery Indicator	15
Installation Warnings	2	Transmitter Batteries	15
Features	3	IFC Batteries	15
Heating Specifications	3	Battery Replacement	15
Safety Precautions	4	Opening the Battery Box	15
Before You Begin	6	Battery Installation	16
Remote Set-Up	7	Transmitter Battery Installation	16
Verify the Switch is on “REMOTE”	7	Power Outages	16
Starting the Heater for the First Time	8	Child-Proof Feature	16
Location of Controls	8	Normal Operating Odors	16
Direct Operation	8	Yearly Service Procedure	17
Continuous/Intermittent Pilot Switch	9	Glass Frame Removal and Installation	18
Switching from Intermittent (IPI) to		Accent Light Replacement	21
Continuous Pilot (CPI)	9	Upper Accent Lights	21
Pilot Fuel Conservation Timer	10	Ember-Glo™ Bulb Replacement	22
Remote Operation	11	Glass Cleaning	23
Display Overview	11	Troubleshooting Table	24
Listen for the “Beep”	11	Location of fuses	24
Manual On-Off / Smart Thermostat / Standard		Wiring Diagram	25
Thermostat	12	Replacement Parts List	26
Mode Controls (Flame, Blower, Accent Light,		Limited Warranty	27
Comfort Control, AUX)	13	Index	28
Mode Controls (continued)	14		

Features

- Works During Power Outages (battery backup)
- GreenSmart™ Thermostat / Remote Control
- Contemporary Look
- Blower for Effective Heat Distribution
- Built-In Accent Light (night light)
- Standing or Intermittent (GreenSmart) Pilot
- Variable-Rate Heat Output
- Low Maintenance
- Ember-Glo lighting
- Realistic “Wood Fire” look

Heating Specifications

	Natural Gas	Propane
Approximate Heating Capacity (in square feet)*	Up to 3,000	Up to 3,000
Maximum BTU Input Per Hour	60,000	60,000

* Heating capacity will vary with floor plan, insulation, and outside temperature.

Safety Precautions

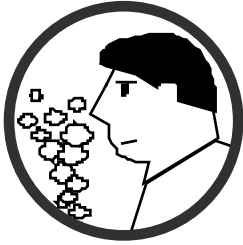

• IF YOU SMELL GAS:

- * Do not light any appliance
- * Extinguish any open flame
- * Do not touch any electrical switch or plug or unplug anything
- * Open windows and vacate building
- * Call gas supplier from neighbor's house, if not reached, call the fire department



This unit must be installed by a qualified installer to prevent the possibility of an explosion. Your dealer will know the requirements in your area and can inform you of those people considered qualified. The room heater should be inspected and cleaned before use and at least annually by a qualified service person. More frequent cleaning may be required due to excessive lint from carpeting, bedding material, etc.

The instructions in this manual must be strictly adhered to. Do not use makeshift methods or compromise in the installation. Improper installation will void the warranty and safety listing.

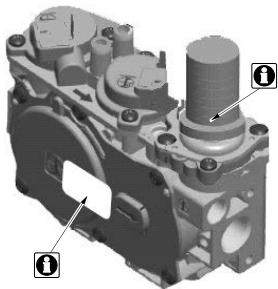

This heater is either approved for natural gas (NG) or for propane (LP). Burning the incorrect fuel will void the warranty and safety listing and may cause an extreme safety hazard. Direct questions about the type of fuel used to your dealer. Check for a label on the flame adjust knob on the gas control valve (this is the best place to check). You may also check for a label on the gas control valve body.



Contact your local building officials to obtain a permit and information on any installation restrictions or inspection requirements in your area. Notify your insurance company of this heater as well.



If the flame becomes sooty, dark orange in color, or extremely tall, do not operate the heater. Call your dealer and arrange for proper servicing.



It is imperative that control compartments, screens, or circulating air passageways of the heater be kept clean and free of obstructions. These areas provide the air necessary for safe operation.



Do not operate the heater if it is not operating properly in any fashion or if you are uncertain. Call your dealer for a full explanation of your heater and what to expect.



Do not store or use gasoline or other flammable liquids in the vicinity of this heater.



Do not operate if any portion of the heater was submerged in water or if any corrosion occurs. Immediately call a qualified service technician to inspect the appliance and to replace any part of the control system and any gas control that has been underwater.



Do not place clothing or other flammable items on or near the heater. Because this heater can be controlled by a thermostat there is a possibility of the heater turning on and igniting any items placed on or near it.

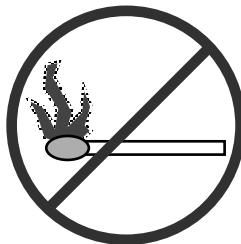

Light the heater using the built-in igniter. Do not use matches or any other external device to light your heater.

Allow the heater to cool before carrying out any maintenance or cleaning.



The viewing glass should be opened only for conducting service. Do not operate with cracked, broken, or removed glass.

Any safety screen or guard removed for servicing must be replaced prior to operating the heater.

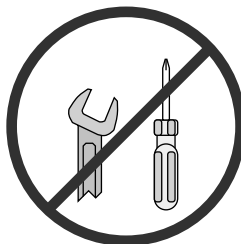

Never remove, replace, modify or substitute any part of the heater unless instructions are given in this manual. All other work must be done by a trained technician. Don't modify or replace orifices.



Operate the heater according to the instructions included in this manual.

If the main burners do not start correctly turn the gas off at the gas control valve and call your dealer for service.

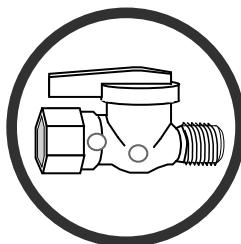

Instruct everyone in the house how to shut gas off to the appliance and at the gas main shutoff valve. The gas main shutoff valve is usually next to the gas meter or propane tank and requires a wrench to shut off.



This unit is not for use with solid fuel

Do not place anything inside the firebox (except the logs/media).

If any component becomes damaged, replace with Travis Industries components.



Do not throw this manual away. This manual has important operating and maintenance instructions that you will need at a later time. Always follow the instructions in this manual.



Children and adults should be alerted to the hazards of high surface temperature and should stay away to avoid burns or clothing ignition. Young children should be supervised when they are in the same room as the heater.



Travis Industries, Inc. grants no warranty, implied or stated, for the installation or maintenance of your heater, and assumes no responsibility of any consequential damage(s).

Before You Begin

- Read this entire manual before you use your new fireplace (especially the section "Safety Precautions" on pages 4 & 5). Failure to follow the instructions may result in property damage, bodily injury, or even death.

Remote Control Warnings

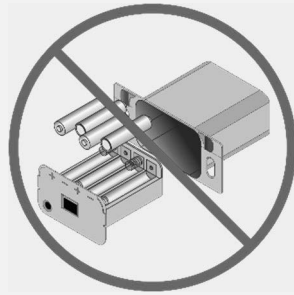

KEEP BATTERIES AND COVER INSTALLED AT ALL TIMES

The remote control system requires the batteries and battery cover to remain in place at all times. Once the batteries or cover are removed, the system may re-start in standing pilot mode. If this occurs when the heater is in Remote Mode, you will not be able to turn the heater off manually from the battery box.

If you need to replace dead batteries, make sure to **turn the appliance off** before removing the batteries.

NOTE: If the batteries go dead, the system will operate normally as long as household power (120v AC) is present.



The transmitter and IFC are radio frequency devices. Placing the transmitter in or near metal may severely reduce the signal range.



Turn off the main gas supply to the appliance during installation or maintenance. In case of remote control malfunction turn off the main gas supply to the appliance.

PROGRAMMING THE REMOTE

The SIT GSR2 remote may be programmed to disable the thermostat or any of the modes (flame height, blower, light, comfort control, Standing Pilot *, or auxiliary power input). This allows you to tailor the remote to the appliance.

* We do not recommend disabling the standing pilot option for our gas appliances. This feature may be recommended for cold regions or installations with sub-optimal venting.

How to Disable/Enable the Thermostat

The remote is shipped with the thermostat enabled.

- Remove one battery from the remote.
- Press and hold the thermostat button while replacing the battery. This will toggle the thermostat function. Repeat this process to toggle the thermostat function to the desired setting.

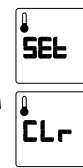
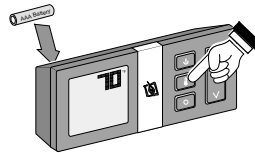

"SET" = thermostat function enabled.

"CLR" = thermostat function disabled.

How to Disable/Enable Modes (Light, Blower, etc.)

- Remove one battery from the remote.
- Press and hold the on/off button and mode button while replacing the battery.

Keep the on/off button depressed during the following steps.

- While keeping the on/off button depressed, press and release the mode button until the mode that needs to be changed is illuminated.
- With the desired mode illuminated (see illustration to the right), press the "up" or "down" button to activate or clear the mode being addressed. Make sure to keep the on/off button depressed during this process.
- Release the on/off button to complete programming.

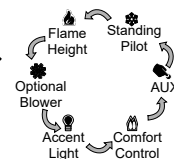
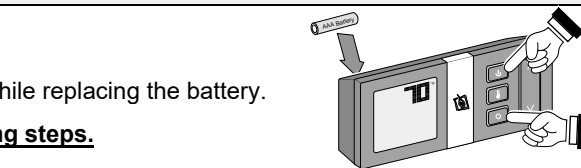

"SET" = selected mode enabled.

"CLR" = selected mode disabled.

Remote Set-Up

Verify the Switch is on “REMOTE”

To access the remote switch, remove the trim and barrier screen (see page 18). The on/remote/off switch on the battery box may then be accessed. This switch must remain in the REMOTE position for the remote to operate.

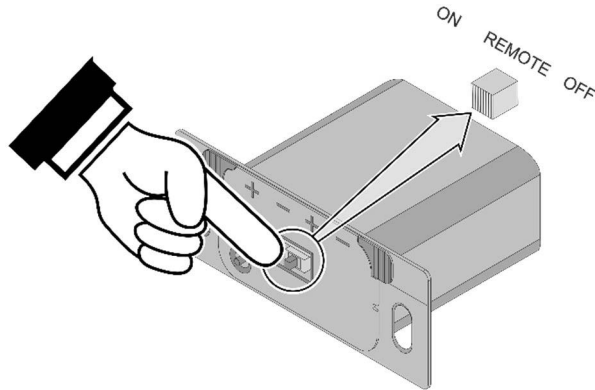

Synchronize the Transmitter to the IFC

The transmitter will need to be synchronized to the IFC (Integrated Fireplace Control) before the remote will work correctly. Synchronizing is done in the following two steps below (see below):

- Press the PRG (Program) button on the battery box (IFC will beep 3 times).
Press the “ON” button on the transmitter (IFC will beep 3 times).

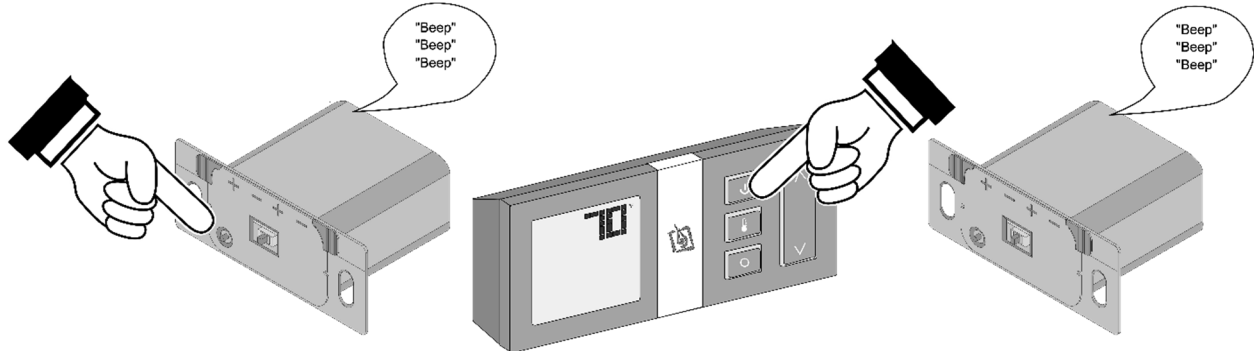

NOTE: If power is cut off to the IFC for an extended period, you may need to re-synchronize the remote.

Clearing the System Memory

This appliance uses an Integrated Fireplace Control (IFC) to store the unique code for the remote control. If you wish to clear the system memory, **MAKE SURE GAS IS TURNED OFF TO THE APPLIANCE** then press the PRG (Program) button for 10 seconds. The pilot will start to spark repeatedly, signifying all system memory has been cleared. The system will return to its original configuration – a remote will need to be synchronized, and the system will operate in Continuous Pilot mode.

Starting the Heater for the First Time

- Burn the heater at a high setting with the blower off for an extended period (between 24 to 48 hours). This will cure the painted surfaces. There may be some odor and light smoke that comes from the surface of the appliance as the paint cures, this is normal. We recommend opening a window to vent the room.
- Condensation may appear on the glass each time you start the heater - this is normal.
- Blue Flames will occur on the heater when it first comes on. After fifteen minutes the flames will turn a more realistic yellow and orange color.
- Verify the batteries are installed (see page 15).

Location of Controls

Most features will be controlled by the included remote.

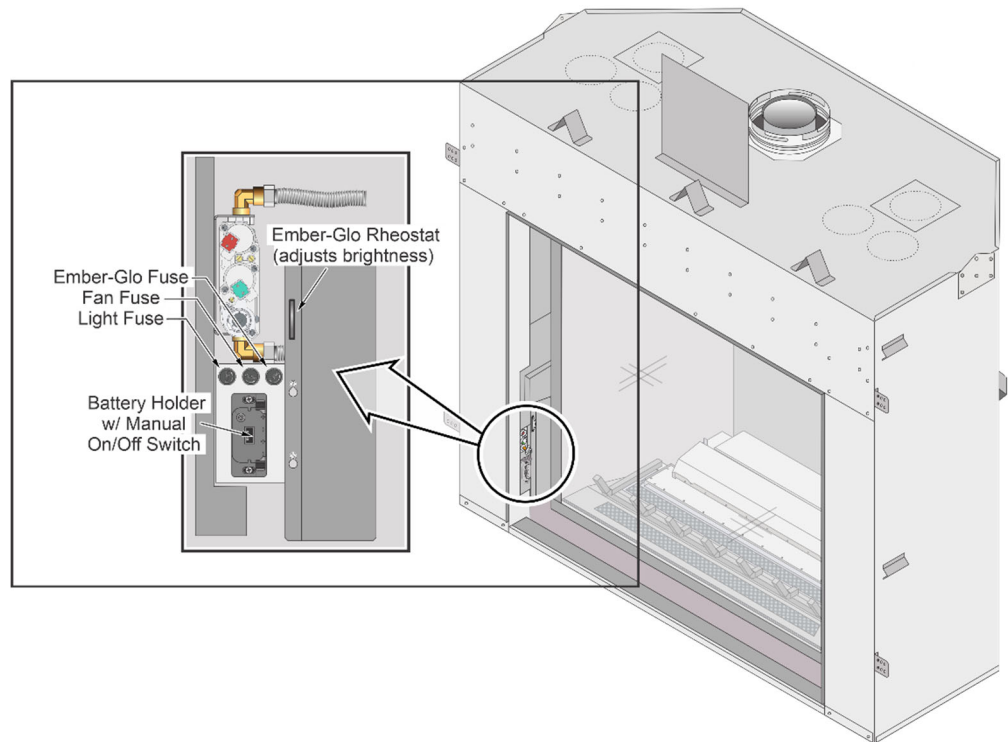
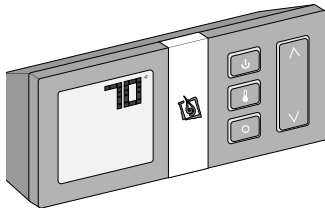

Direct Operation

We recommend using the remote to operate the fireplace. If you do need to operate the fireplace directly, remove the left side trim (see page 19). The on/remote/off switch on the battery box may then be accessed.

ON – Burner turns on (regardless of transmitter settings).

OFF – Burner turns off (regardless of transmitter settings).

REMOTE – Burner is controlled by the transmitter.

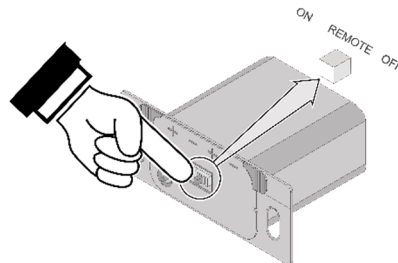

NOTE: When the battery holder switch is turned to ON or OFF, the mode settings (Flame Height, etc.) will remain in the same state as before the switch was moved (i.e.: the IFC “remembers” the last setting). If you wish to adjust the mode settings use the transmitter mode button to adjust the settings. The thermostat and burner on/off operating functions will not work on the transmitter.

Continuous/Intermittent Pilot Switch

This heater may run with the pilot continuously running or in Intermittent mode. For most homeowners, Intermittent mode is preferable (this saves fuel, doesn't give off un-needed heat). However, in some situations, the homeowner may prefer to switch the heater to Continuous Pilot mode. The most typical reasons for switching to Continuous Pilot are:

- **Very Cold Conditions** – In very cold conditions, you may notice that the burner does not light quickly, and the flames lift off the burner. If this is the situation, we recommend you switch to continuous pilot. This will create a slight draft in the vent, allowing for the burner to light quickly and draft correctly.
- **Excessive Condensation on Glass After Startup** – Certain installations may encounter excessive fogging on the window after startup (not just the first time the heater was started). This is an aesthetic condition that may be remedied by switching the heater to continuous pilot.
- **Cold Glass or Heater Front** – In very cold conditions you may notice that the heater front and glass become very cold. To remedy this, switch the heater to continuous pilot.
- **Frequent On / Off Operation** – If you are frequently turning the heater on and off, you may wish to leave it in continuous pilot. This allows the burner to turn on more quickly, without pilot ignition delay.

Switching from Intermittent (IPI) to Continuous Pilot (CPI)

The pilot mode on this appliance is adjusted using the remote. With the remote in the off position (thermostat off, manual off), follow the directions below to adjust the pilot mode.

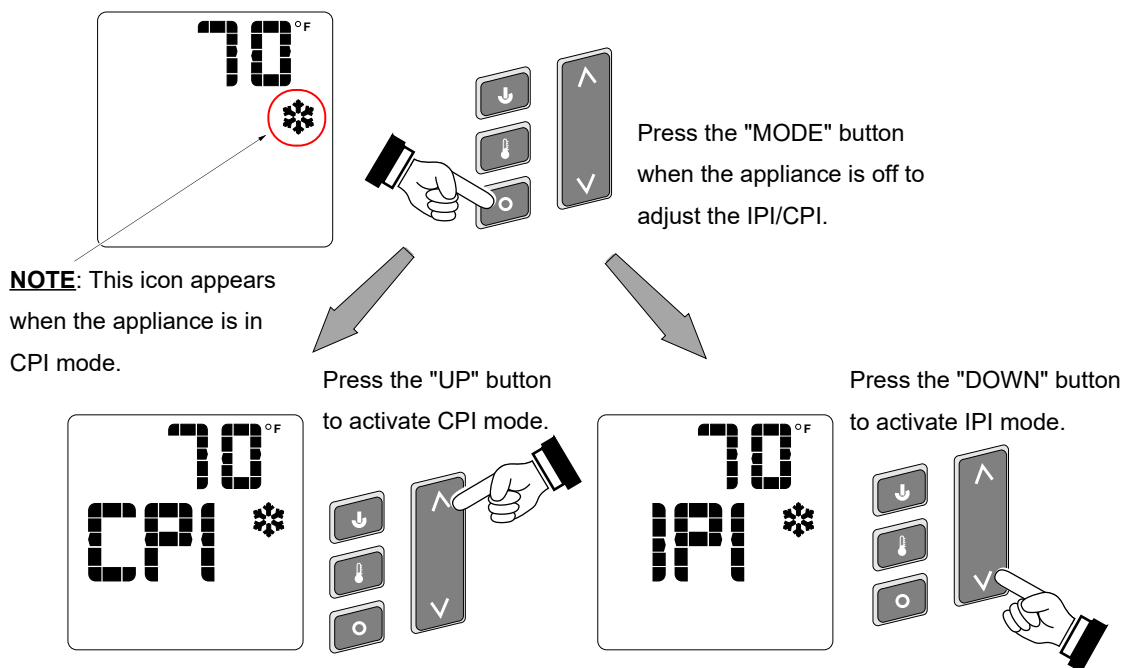

Pilot Fuel Conservation Timer

7 Day Pilot Shutoff Timer (applies to units in CPI mode only)

This appliance may be equipped with a 7 day pilot shutoff timer. This timer helps conserve fuel and save money by turning the pilot off when the appliance is not used for 7 days (this timer is mandated in certain areas for conservation purposes). This applies only when the unit is in CPI (Continuous Pilot Ignition) mode. If the unit is in IPI (Intermittent Pilot Ignition) mode, the timer does not apply.

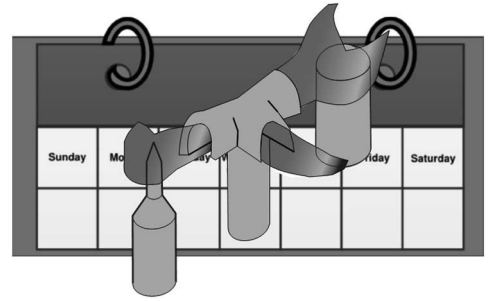

When in CPI mode the pilot will remain lit as long as the burner is engaged within a 7 day window. Each time the burner is turned on the 7 day timer resets. If the burner is not engaged within the 7 day window, the pilot will automatically revert to IPI mode and turn off to conserve fuel.

To switch back to CPI, simply:

GSB2 Units: toggle the IPI/CPI switch to IPI, then back to CPI.

GSR2 Units: use the remote to toggle from IPI mode, then back to CPI mode.

To prevent the need to reset the pilot mode during the heating season, we have listed a few strategies below:

Option 1: Remember to periodically turn on the heater during the heating season

If you use your heater for supplemental heat, this may be the best solution. Set a specific time, once or twice per week (e.g. 5 pm on Tuesday & Friday) to turn the heater on for a few minutes. This will reset the timer and prevent the need to restart the pilot.

Option 2: Use a thermostat

GSR Units: Use the thermostat included with the appliance

GSB Units: Consult your dealer for thermostats compatible with your appliance.

The use of a thermostat will keep the room at a constant temperature and will, in most cases, keep the heater working throughout the heating season. Light the pilot at the beginning of the heating season and set the thermostat to the desired room temperature. As long as the outside temperature does not rise excessively, for seven days or more, the pilot will continue to operate.

Option 3: Use a programmable thermostat (GSB2 Only)

A programmable thermostat may be set to turn on, once per week, to a high temperature for a short time. This will reset the 7-day timer and allow the heater to operate without having to restart the pilot.

Remote Operation

When the switch on the battery holder is set to “REMOTE” the transmitter operates the fireplace. Once you understand how the transmitter works, you will be able to operate your fireplace quickly and easily.

Display Overview

The transmitter display has four main sections (see below).

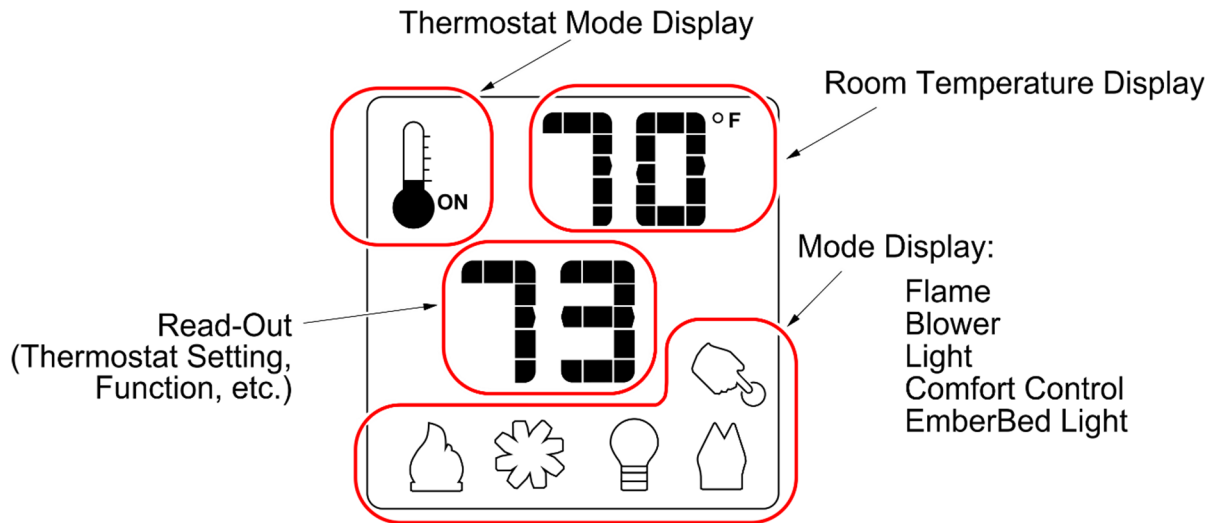

Listen for the “Beep”

Each time you press a button on the transmitter that controls the fireplace, a “beep” will sound from the IFC. When you change thermostat target settings the IFC will not beep.

NOTE: When the batteries start to get low, the IFC will beep twice whenever a button is pressed. When the batteries are nearly depleted, the IFC will no longer beep. See “IFC Batteries” on page 15).

Manual On-Off / Smart Thermostat / Standard Thermostat

Use the thermostat button to cycle through the three thermostat settings (see below).

Look here for the thermostat setting.

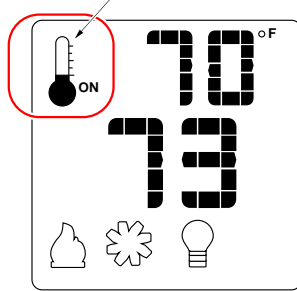

Press the thermostat button to cycle through the thermostat settings.

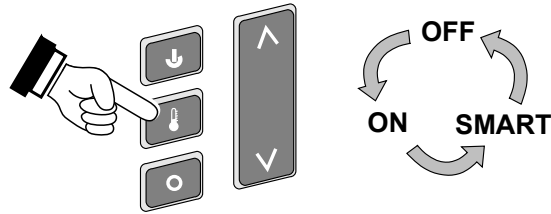

- **MANUAL ON/OFF** – The burner will turn on and off using the remote (see below). Press the On/Off button to control the burner. When off, the display will only show the current temperature.

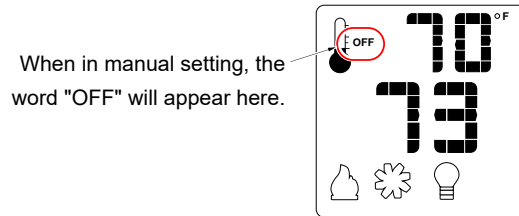

When in manual setting, the word "OFF" will appear here.

- **SMART THERMOSTAT** – While in Smart Thermostat mode, the transmitter will control the burner to achieve the target temperature (see below). Flame height will be adjusted up or down to allow operation without turning the burner on and off (also called “smart modulation”). To adjust the target temperature, press the UP and DOWN buttons until a suitable temperature is achieved.

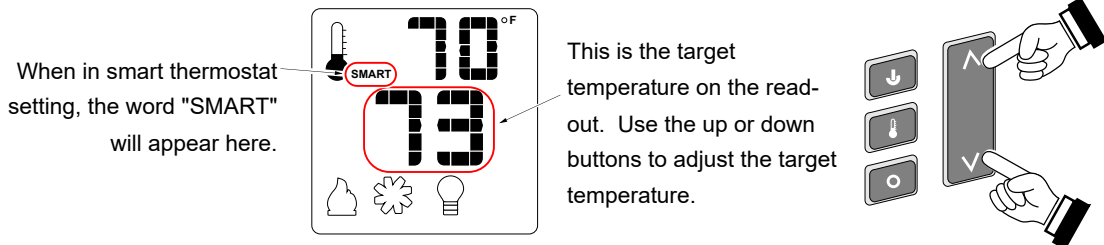

When in smart thermostat setting, the word "SMART" will appear here.

This is the target temperature on the read-out. Use the up or down buttons to adjust the target temperature.

- **STANDARD THERMOSTAT** - While in Standard Thermostat mode, the transmitter will turn the burner on and off to achieve the target temperature (see below). To adjust the target temperature, press the up and down buttons until a suitable temperature is achieved.

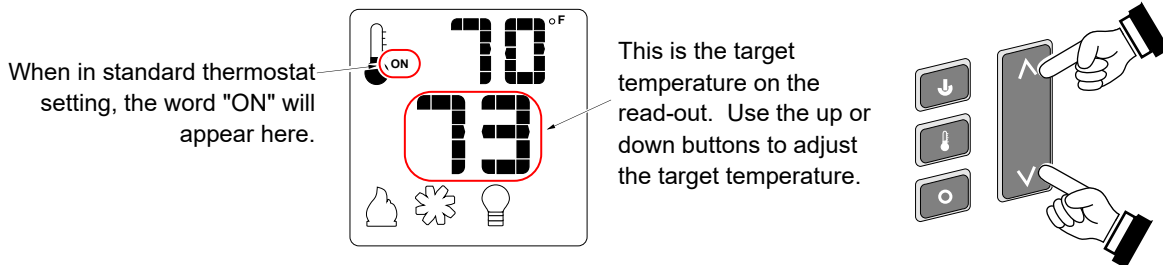

When in standard thermostat setting, the word "ON" will appear here.

This is the target temperature on the read-out. Use the up or down buttons to adjust the target temperature.

NOTE: If the transmitter batteries go dead while in the thermostat setting (standard or smart), the appliance will shut off after approximately 24 hours.

Mode Controls (Flame, Blower, Accent Light, Comfort Control, AUX)

Press the Mode button to cycle through the five mode controls (see below).

Press the mode button to cycle through the mode settings.

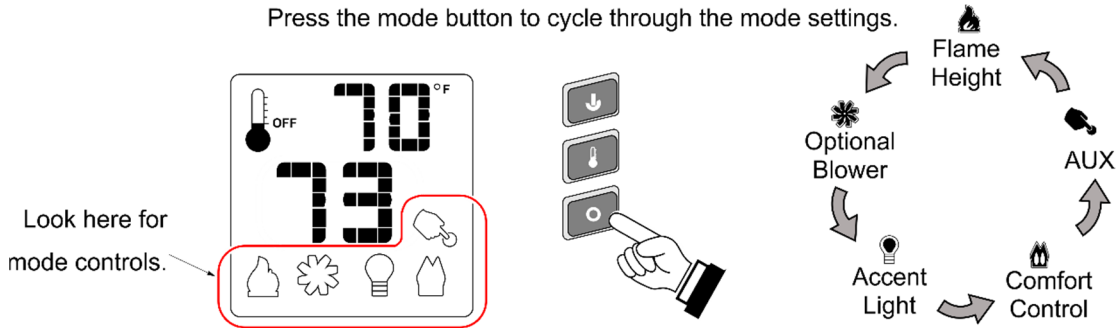

Flame Height

Flame height may be controlled using the UP and DOWN buttons when in Flame Height Mode (see below). The center display will display the 7 settings, from “OFF” to “HI” for full on.

NOTE: Flame height may not be adjusted if operating in Smart Thermostat mode.

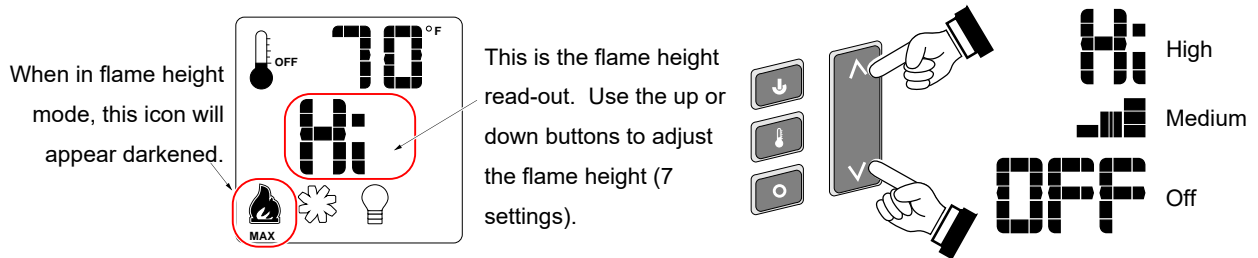

Blower Speed

The blower may be controlled using the up and down buttons when in Blower Speed mode (see below). The center display will display the 7 settings, from “OFF” to “HI” for full on.

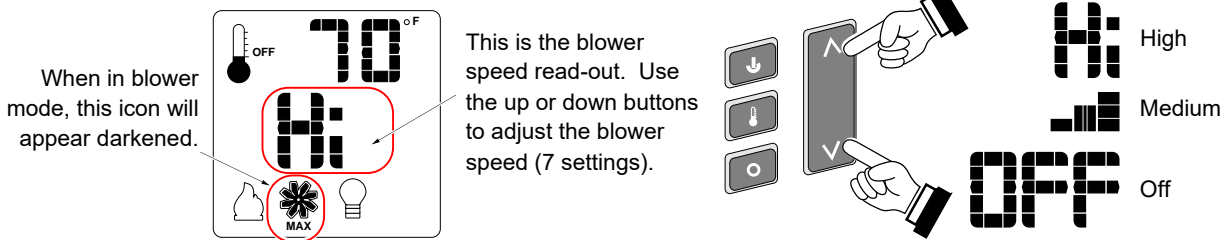

MANUAL MODE – BLOWER OPERATION

When in Manual mode the blower will remain on, even if the burner is turned off and the heater cools.

Either manually turn the blower off, or turn off the heater by pressing the On/Off button. 

Mode Controls (continued)

Accent Light

The Accent Light (night light) inside the heater may be turned on and off using the up and down buttons when in Accent Light mode (see below). The center display will display the 7 settings, from “OFF” to “HI” for full on.

When in accent light mode, this icon will appear darkened.

This is the accent light read-out. Use the up or down buttons to adjust the accent light brightness (7 settings).

High
Medium
Off

HINT: If you wish to leave the accent light on while turning the burner off, adjust the Flame Height setting to “OFF” (see above).

Comfort Control (rear burner)

The comfort control (rear burner) may be turned on and off using the up and down buttons when in Comfort Control Mode (see below). The center display will display either “ON” or “OFF”.

When in comfort control mode, this icon will appear darkened.

This is the comfort control read-out. Use the up button to turn on, down button to turn off (2 settings).

On
Off

Ember-Glo Light (AUX)

The Ember-Glo light may be turned on and off using the up and down buttons (see illustration below). You can adjust the brightness of the light using the built-in rheostat.

When in EmberBed mode (AUX), this icon will appear darkened and the readout will display status.

Use the rheostat on the fireplace to control the EmberBed brightness.

EMBERBED LIGHT

Display Fahrenheit or Celsius

With the system in the “OFF” position, press both the MODE and THERMOSTAT buttons simultaneously to toggle between Fahrenheit (F) and Celsius (C).

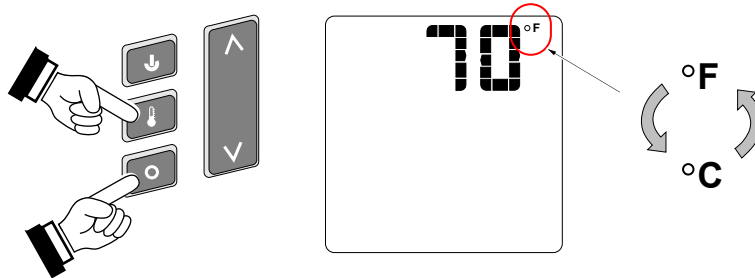

Low Battery Indicator

Transmitter Batteries

The transmitter has a battery-level indicator. When it indicates low battery voltage (see below), install three new AAA alkaline batteries into the transmitter (see “Battery Replacement” on page 15).

Low Battery Indicator

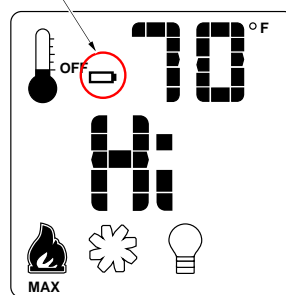

IFC Batteries

The IFC (Integrated Fireplace Control) will “beep” twice when a transmitter button is pressed when the batteries are low. Install four new AA alkaline batteries into the battery box when this occurs (see “Battery Replacement” on page 15). In applications where the appliance is required to provide heat, we recommend replacing the batteries before each heating season.

Battery Replacement

Opening the Battery Box

To access the battery box, remove the trim and barrier screen (see page 18). The battery box can be found on the left side of the firebox below the gas valve.

There are (2) locking tabs in the upper corners of the face of the battery box. Slide the tabs to the side and the battery tray will pop outward enough to allow you to grab it. Pull the battery tray forward and remove it from the battery box.

NOTE: When re-installing the battery tray, make sure to secure the battery tray into the battery box using the locking tabs to ensure a good electrical connection.

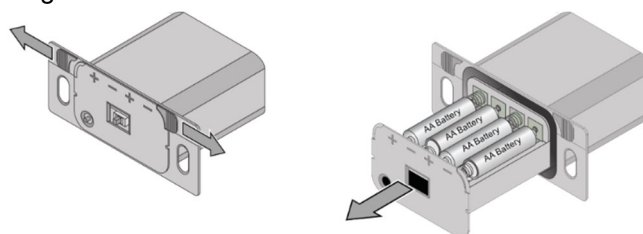

Battery Installation

Fireplace Battery Installation

Install (4) AA batteries into the battery box. These batteries act as a power backup in case the household (AC) current goes out.

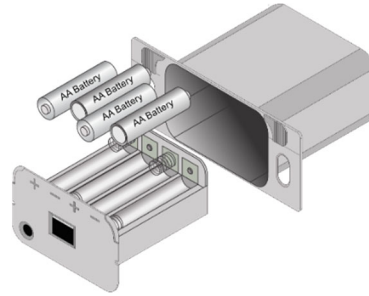

Transmitter Battery Installation

Install the (3) included AAA batteries into the remote.

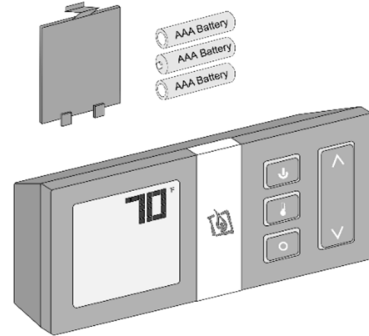

Power Outages

The remote will work if the household current (AC power) is disconnected. The batteries inside the battery box will continue to power the heater but the lights and blowers will not operate.

Child-Proof Feature

The child-proof feature disables the control buttons, preventing unwanted use of the remote.

- Press both the MODE and UP buttons simultaneously to turn this feature on or off.

HINT: This feature is especially useful while using the thermostat setting.

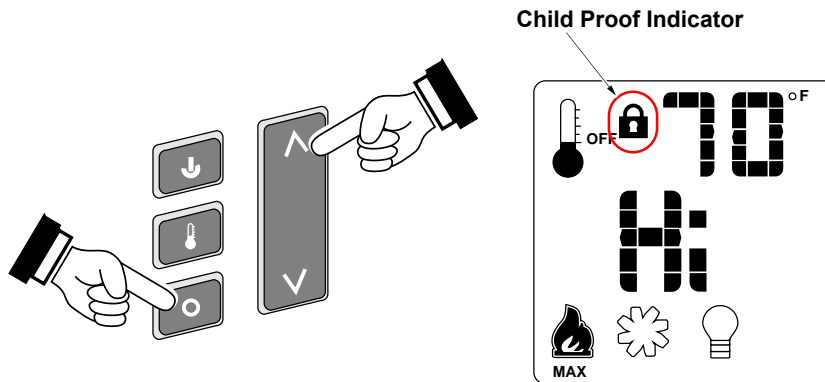

Normal Operating Odors

This appliance has several areas that reach high temperatures. Dust or other particles on these areas may burn and create an odor. This is normal during startup. You may notice the smell is more acute if the appliance was left idle for a long period.

Yearly Service Procedure

WARNING: Failure to inspect and maintain the stove may lead to improper combustion and a potentially dangerous situation. We recommend the following procedures be done by a qualified technician.

- Shut off gas to the fireplace and let it cool for 15 minutes. Remove the glass. Inspect and operate the pressure relief mechanism to verify relief mechanisms are free from obstruction to operate.
- Clean glass window with a suitable fireplace glass cleaner. Abrasive cleaners must not be used. Be careful not to scratch the glass when cleaning.
- Vacuum and clean any debris in the firebox.
- Check all accessible gas-carrying tubes, connections, pipes, and other components for leaks.
- Inspect the burner and firebox. Make sure the burner is not warped, cracked, or damaged. Check the firebox and area around the pilot to make sure there is no damage. Inspect primary air openings for blockage. If any problem is found, discontinue use and contact your dealer for service.
- Inspect the area behind the access door; clean if necessary. Check the gas control valve and the gas lines. If damage is found, discontinue use and contact your dealer for service. Clean the air channels, ducts, and blower (if applicable)
- Inspect vent and vent termination for sooting, obstructions, or damage. Make repairs as needed. Remove any debris or vegetation near the vent termination. Contact your dealer if any sooting or deterioration is found near the vent termination.
- Reinstall the glass assembly. If the glass is damaged, replace it. Make sure the gasket along the perimeter of the glass contacts the face of the firebox and forms an air-tight seal. If it does not, re-align or replace the gasket to ensure an air-tight seal.
- Turn the pilot flame on (continuous pilot). It should touch approximately 3/8" of the top of the flame sensor (see below). If it does not, contact your dealer.

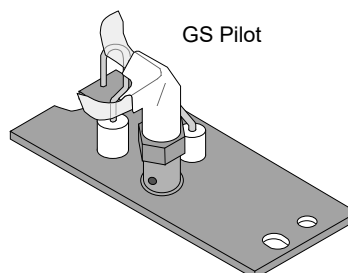

- Start the main burner. Inspect and ensure the lighting of the main burner occurs within 4 seconds of the main gas valve opening.
- Test the flame failure response time of the flame safety system. It must de-energize the safety shutoff in no more than 30 seconds.
- After 15 minutes the flames should be orange/yellow and not touch the top of the firebox. If the pilot or main burners do not burn correctly, contact your dealer for service. Monitor blower operation

Glass Frame Removal and Installation



A barrier designed to reduce the risk of burns from the hot viewing glass is provided with this appliance and shall be installed for the protection of children and other at-risk individuals.



If the barrier becomes damaged, the barrier shall be replaced with the manufacturer's barrier for this appliance.



The appliance must be completely cool before removing the glass.



Do not strike or slam the glass.



Warning: Do not operate appliance with the glass front removed, cracked, or broken. Replacement of the glass should be done by a licensed or qualified service person.

GLASS FRAME TOOL

The glass frame tool is shipped inside the fireplace, on the right side of the fireplace opening. The first time it is used you may need to loosen the screw (1/4" wrench). The tool is accessed after removing the screen.



NOTE: Replace the tool in this location after use.

1. Remove the trim and place it aside.

a) The side trim has a small tab on the upper edge. Use the tab to lift the trim straight up. When the hooks that secure the trim to the fireplace are free, remove the trim from the fireplace opening and set it aside.

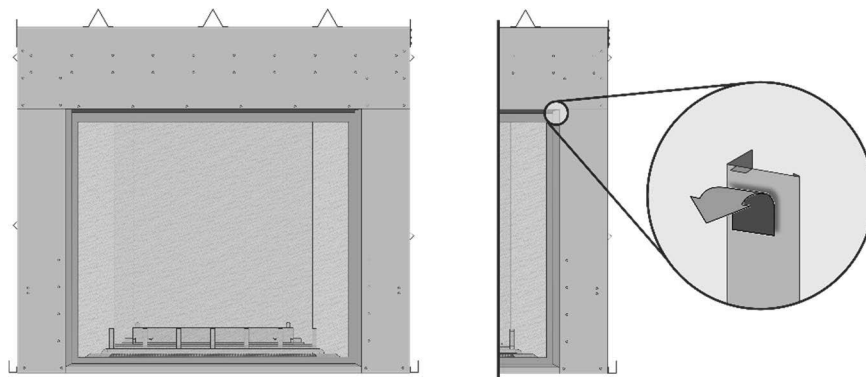

b) Lift the bottom trim straight up. When the trim is above the front edge of the fireplace opening, remove it from the fireplace and set it aside.

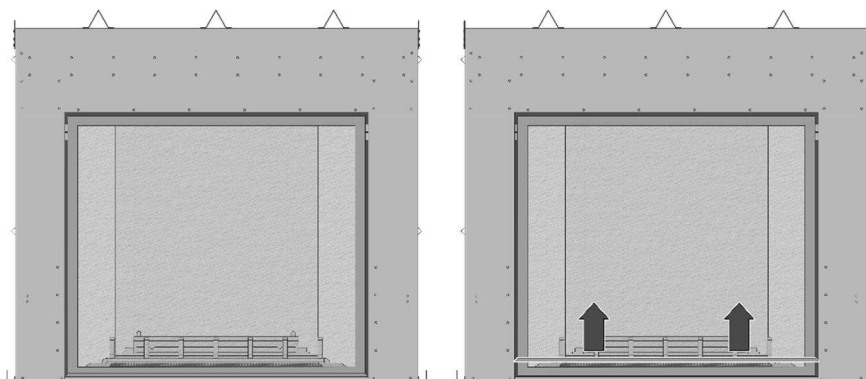

c) Tip the barrier screen outward and remove the screen.

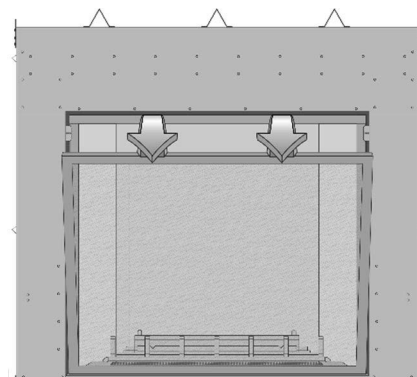

d) The screen rests against (2) tabs on the upper sides of the fireplace opening. Slide the tabs behind the front wall of the fireplace to make room for the removal of the glass assembly.

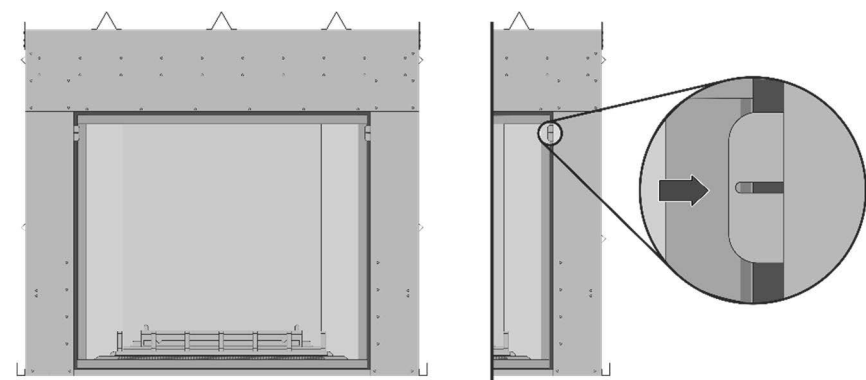

2. Use the glass latch tool to unlatch the glass frame on the two upper sides of the assembly. Tilt the top edge forward and lift to free the tabs on the bottom of the glass assembly out of the slots on the bottom of the fireplace opening. Remove the glass frame from the fireplace.

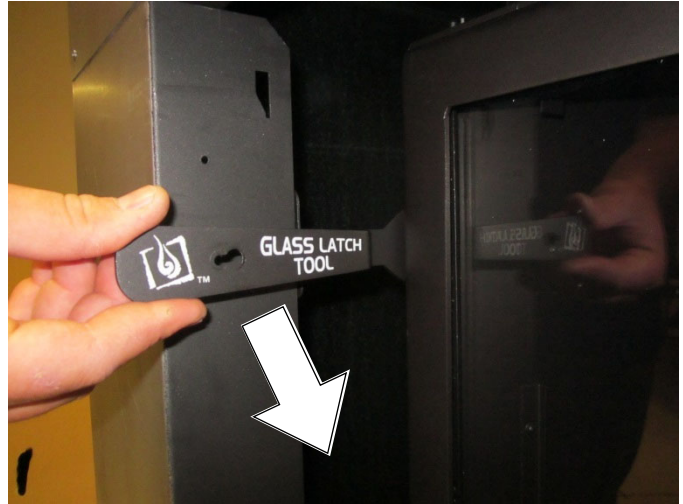

Accent Light Replacement

- Shut off power to the fireplace.
- Shut off gas to the fireplace and let it cool for 15 minutes.
- Remove the glass (see page 18) and media.
- Replace the halogen bulbs with the following bulbs:
35 Watt 120 Volt T4 Halogen Bulb (GY6.35 Base)



NOTE: Take care to not touch the bulbs with your fingers – use foam packing or a paper towel to handle the bulbs:

Upper Accent Lights

- The upper accent light can be accessed by removing the (4) nuts with a 3/8" nut driver, as shown below. The upper accent light assembly drops down to expose the accent light.

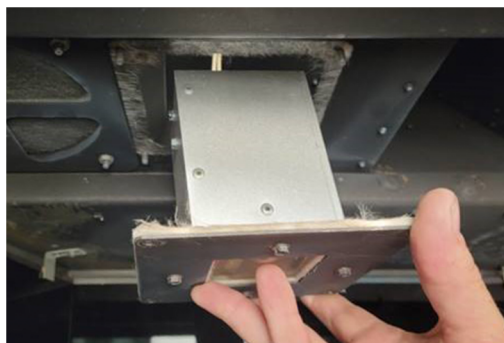

When replacing the assembly, carefully insert the wiring into this cavity to ensure the wiring is not pinched.

- Use a 1/4" nut driver to loosen the (4) screws that secure the bulb holder to the light assembly and remove the bulb holder from the assembly.

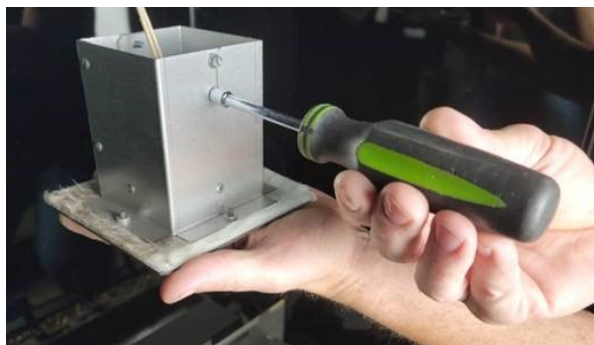

- Loosen the two screws nearest the bulb to disengage the bulb from the holder. Remove the bulb from the holder. Replace the bulb, making sure not to touch the bulb with your fingers (grasp the bulb with the bulb packaging or a paper towel). Tighten the screws until the bulb is secure (do not over-tighten; this may damage the electrical contacts on the bulb).
- Return the fireplace to its correct configuration.

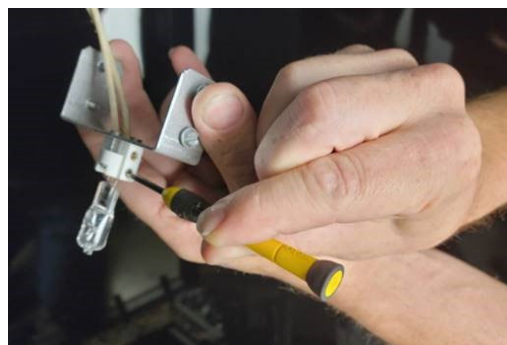

Ember-Glo™ Bulb Replacement



The appliance must be completely cool prior to conducting service.

The accent lights in your heater provide additional lighting. The bulbs will burn out over time. To replace, follow the directions below:

- Replace the halogen bulbs with the following bulbs:

35 Watt 120 Volt T4 Halogen Bulb (GY6.35 Base)



- Shut off gas to the heater and let it cool completely.
- Remove the barrier screen and glass assembly (see Glass Frame Removal and Installation on pg. 18).

- Remove the (3) logs indicated to improve access.

HINT: Take a picture of the log placement before you remove the logs to help with proper placement when reinstalling them.



- Remove the Ember-Glo™ glass from the log grate forward



- Use a 1/4" nut driver to remove the screws that secure the media tray to the fireplace (keep the screws for reinstallation). Remove the media tray from the firebox.



- Remove the bulb by pulling the bulb straight out of the socket as shown to the right.

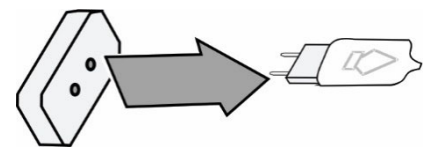

- Gently insert the pins on the replacement bulb into the holes on the socket.

NOTE: Take care to not touch the replacement bulbs with your fingers – use foam packing or paper towel to hold the bulb

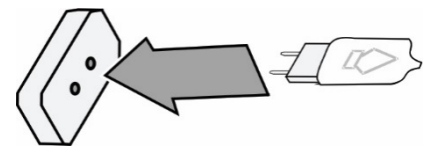

- Return the fireplace to its correct configuration.

Glass Cleaning

The glass may be cleaned with a non-abrasive cleaner. To clean the inside of the glass, simply remove the glass frame, place it on a non-scratching surface, and clean the surface.

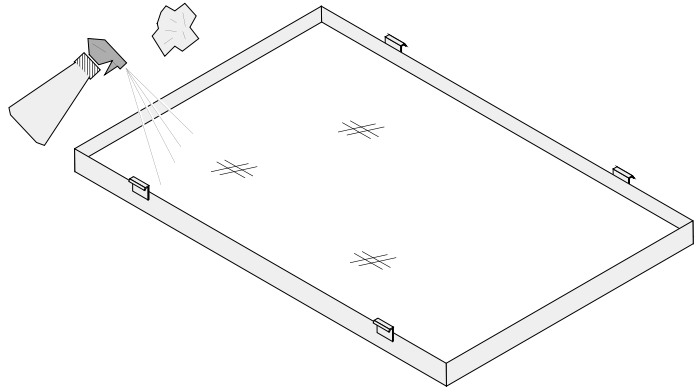

WARNING: do not operate the fireplace without the glass frame in place.

Troubleshooting Table

Problem:	Possible Cause:	Don't Call for Service Until You:
Burner Will Not Start	The battery box switch is turned to "OFF" The remote control is not working correctly..... The thermostat is disconnected or set too low..... No propane in tank.....	Turn the battery box switch to "ON". See the remote control instructions. See "Thermostat Operation". Check Tank Level.
Flashing RED LED on Control Module	The power backup batteries are dead (LED will flash once repeatedly)..... The heater encountered an error when trying to start (LED will flash 3 times repeatedly) The heater encountered a pilot error (LED will flash 2 times repeatedly)	Replace the batteries (see page 15) Make sure gas is turned on. Turn the heater off for 5 seconds (make sure standing pilot is off) – then turn back on. Contact your dealer if this occurs.
Thermostat Does Not Work	The battery box switch is turned to "OFF" or "ON". The thermostat is set too low.....	Turn the battery box switch to "REMOTE". Check thermostat.
Blower Does Not Work	The fireplace is not getting electricity..... The fireplace is not up to temperature..... The blower fuse may be blown.....	Check the breaker switch. Let the fireplace burn for 10 minutes. Replace the fuse. See fuse location below.
Fireplace Will Not Distribute Heat	The fireplace is not getting electricity..... The fireplace is not up to temperature.....	Check the breaker switch. Let the fireplace burn for at least 15 minutes.
Flames Are Too Blue	The fireplace has just been started..... Improper air shutter adjustment.....	This is normal - see "Starting the Fireplace for the First Time". Adjust Air Shutter - contact your dealer.
Flames Are Too Short (Under 6")	The flame height may be turned too low.....	Turn the flame height to "HI" - See "Adjusting the Flame Height".
Thin Layer of Soot Covers the Glass	Crushed glass or media is placed incorrectly..... Improper air shutter adjustment.....	See "Log Installation" in the installation manual. Adjust air shutter - contact your dealer.
Accent Lights Do Not Work	The bulb may be burned out..... The accent light fuse may be blown.	See "Accent Light Replacement" page 18. Replace the fuse. See fuse location below.

Location of fuses

The (3) 3 amp fuses are found behind the left side trim (see page 19).

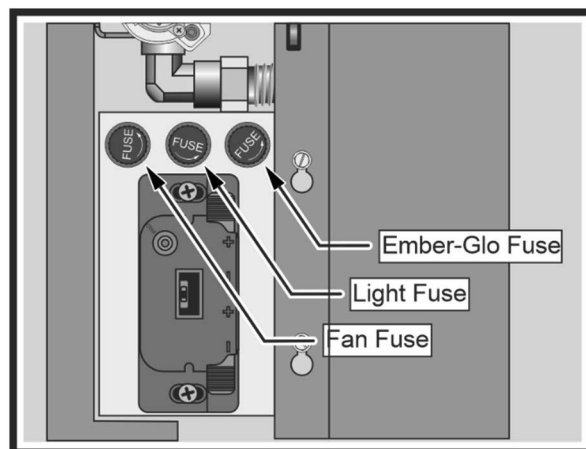

Wiring Diagram

Caution: Label all wires prior to disconnection when servicing controls. Wiring errors can cause improper and dangerous operation.

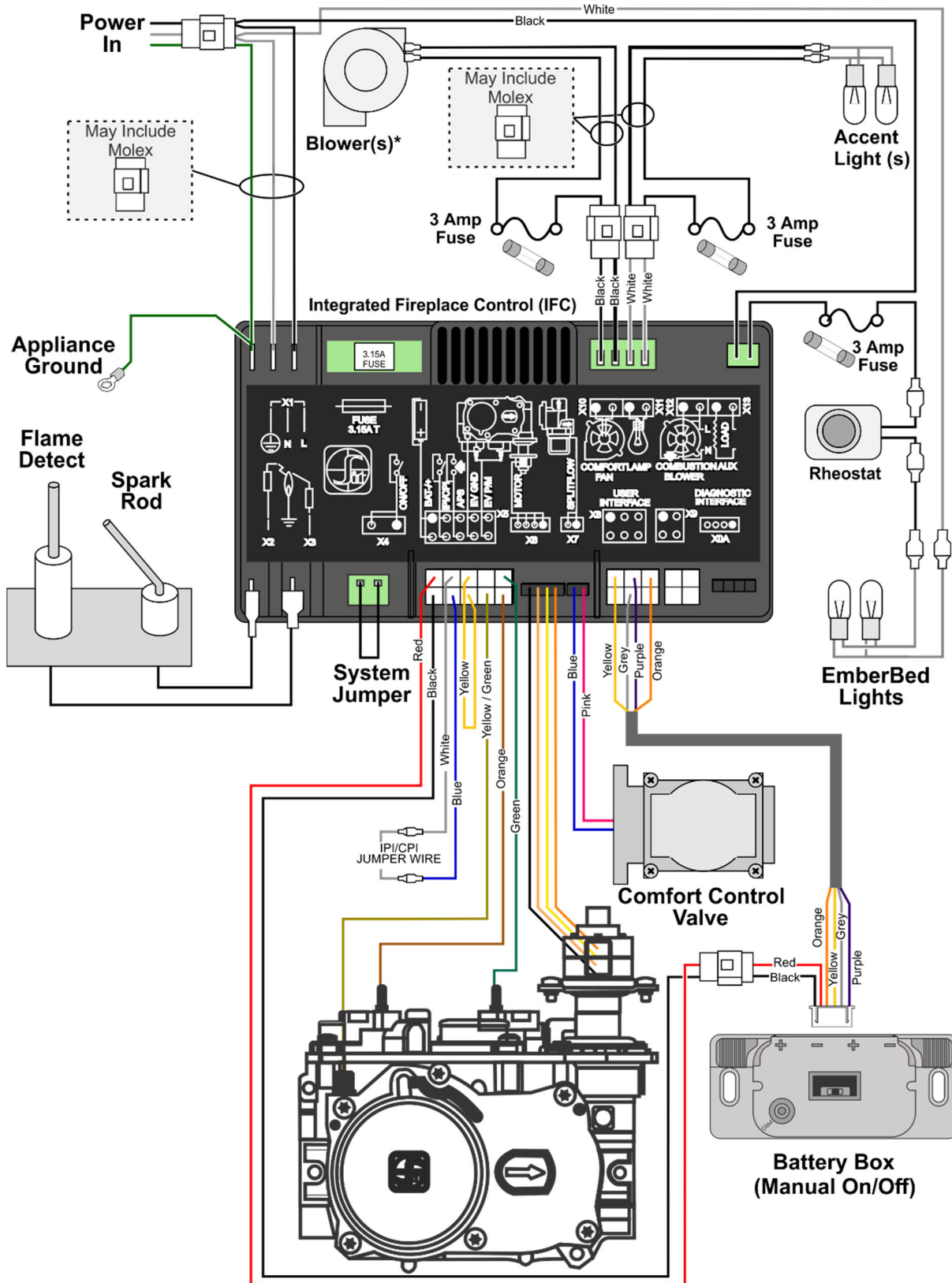

Replacement Parts List

Caution: Use only Travis Industries replacement parts. Do not use substitute materials.

Warning: Do not operate the appliance with the glass front removed, cracked, or broken. Replacement of the glass should be performed by a licensed or qualified service person.

DESCRIPTION	PART #
GLASS w/FRAME	250-04104
SCREEN BARRIER, FRONT	250-05602
PILOT ASS'Y, 3-WAY PSE	250-04094
VALVE, NG w/STPR MTR	250-03185
STEPPER MOTOR, LP GS	250-01463
FUSE, 3AMP, 1/4 dia 5-PK	250-03000
BLOWER ASSY LEFT	250-04053
BLOWER ASSY RIGHT	250-04055
CONTROL MODULE	250-03826

Contact your local Travis dealer to purchase replacement parts.

Limited Warranty

Register your TRAVIS INDUSTRIES, INC. Limited 7 Year Warranty online at traviswarranty.com. TRAVIS INDUSTRIES, INC. warrants this gas appliance (appliance is defined as the equipment manufactured by Travis Industries, Inc.) to be defect-free in material and workmanship to the original purchaser from the date of purchase as follows:

Check with your dealer in advance for any costs to you when arranging a warranty call. Mileage or service charges are not covered by this warranty. This charge can vary from store to store.

Component	Years 1 & 2 Parts & Labor	Years 3 Through 5 Parts & Labor	Years 6 & 7 Parts Only
<u>Burner Assembly</u> Burner Pan Assembly, Air Shutter Assembly, Main Burner Orifice	✓		
<u>Electrical Assembly (within heater structure):</u> Wiring harness, snap discs, rheostat speed control	✓		
<u>Gas Control Assembly</u> Adjustable control valve, fireplace controller, pilot assembly, and pilot wiring	✓		
<u>Glass</u> Glass (breakage from thermal shock)	✓		
<u>Gold, Nickel & Copper Plating</u> Face & Door (see "Conditions and Exclusions" # 9)	✓		
<u>Accessories</u> Firebacks, Power Heat Ducts, Andirons, etc...	✓		
<u>One-Way Freight Allowance</u> One-way freight allowance on pre-authorized repair done at the factory is covered.	✓	✓	
<u>Convection Heat Exchanger</u> Convection heat exchanger assembly	✓	✓	
<u>Firebox Assembly</u> Adjustable Air Restrictor, Pressure Relief Mechanisms, Glass Attachment Mechanism	✓	✓	✓

EXCLUDED COMPONENTS:

Paint, Gasketing, and Accent Light Bulbs

CONDITIONS & EXCLUSIONS

- This new gas appliance must be installed by a qualified gas appliance technician. It must be installed, operated, and maintained at all times in accordance with the instructions in the Owner's Manual. Any alteration, willful abuse, accident, neglect, or misuse of the product shall nullify this warranty.
- This warranty is nontransferable and is made to the ORIGINAL purchaser, provided that the purchase was made through an authorized TRAVIS dealer.
- Discoloration and some minor expansion, contraction, or movement of certain parts and resulting noise, is normal and not a defect and, therefore, not covered under warranty. The installer must ensure the appliance is burning as per the rating tag at the time of installation. Over-firing (operation above the listed BTU rate) of this appliance can cause serious damage and will nullify this warranty.
- The warranty, as outlined within this document, does not apply to the chimney components or other Non-Travis accessories used in conjunction with the installation of this product. If in doubt as to the extent of this warranty, contact your authorized TRAVIS retailer before installation.
- Travis Industries will not be responsible for inadequate performance caused by environmental conditions such as nearby trees, buildings, rooftops, wind, hills, or mountains or negative pressure or other influences from mechanical systems such as furnaces, fans, clothes dryers, etc.
- This Warranty is void if:
 - The unit has been operated in atmospheres contaminated by chlorine, fluorine, or other damaging chemicals.
 - The unit is subject to submersion in water or prolonged periods of dampness or condensation.
 - Any damage to the unit, combustion chamber, heat exchanger, or other components due to water, or weather damage which is the result of, but not limited to, improper chimney/venting installation.
- Exclusions to this 7 Year Warranty include: injury, loss of use, damage, failure to function due to accident, negligence, misuse, improper installation, alteration or adjustment of the manufacturer's settings of components, lack of proper and regular maintenance, damage incurred while the appliance is in transit, alteration, or act of God.
- This 7 Year warranty excludes damage caused by normal wear and tear, such as paint discoloration or chipping, worn or torn gasketing, corroded or cracked logs, embers, etc. Also excluded is damage to the unit caused by abuse, improper installation, modification of the unit, drilling of the orifices, or the use of fuel other than that for which the unit is configured. Units are shipped for natural gas and must be converted to propane using the included conversion kit. Confirm fuel configuration with your installer.
- Damage to gold or nickel surfaces caused by fingerprints, scratches, melted items, or other external sources left on the gold or nickel from the use of cleaners other than denatured alcohol is not covered in this warranty.
- TRAVIS INDUSTRIES, INC. is free of liability for any damages caused by the appliance, as well as inconvenience expenses and materials. Incidental or consequential damages are not covered by this warranty. In some states, the exclusion of incidental or consequential damage may not apply.
- This warranty does not cover any loss or damage incurred by the use or removal of any component or apparatus to or from the gas appliance without the express written permission of TRAVIS INDUSTRIES, INC. and bearing a TRAVIS INDUSTRIES, INC. label of approval.
- Any statement or representation of TRAVIS products and their performance contained in TRAVIS advertising, packaging literature, or printed material is not part of this 7 year warranty.
- This warranty is automatically voided if the appliance's serial number has been removed or altered in any way. If the appliance is used for commercial purposes, it is excluded from this warranty.
- No dealer, distributor, or similar person has the authority to represent or warrant TRAVIS products beyond the terms contained within this warranty. TRAVIS INDUSTRIES, INC. assumes no liability for such warranties or representations.
- Travis Industries will not cover the cost of the removal or re-installation of hearths, facing, mantels, venting, or other components.
- If for any reason any section of this warranty is declared invalid, the balance of the warranty remains in effect and all other clauses shall remain in effect.
- THIS 7 YEAR WARRANTY IS THE ONLY WARRANTY SUPPLIED BY TRAVIS INDUSTRIES, INC., THE MANUFACTURER OF THE APPLIANCE. ALL OTHER WARRANTIES, WHETHER EXPRESS OR IMPLIED, ARE HEREBY EXPRESSLY DISCLAIMED AND THE PURCHASER'S RECOURSE IS EXPRESSLY LIMITED TO THE WARRANTIES SET FORTH HEREIN.

IF WARRANTY SERVICE IS NEEDED:

- If you discover a problem that you believe is covered by this warranty, you MUST REPORT it to your TRAVIS dealer WITHIN 30 DAYS, giving them proof of purchase, the purchase date, and the model name and serial number.
- Travis Industries has the option of either repairing or replacing the defective component.
- If your dealer is unable to repair your appliance's defect, he may process a warranty claim through TRAVIS INDUSTRIES, INC., including the name of the dealership where you purchased the appliance, a copy of your receipt showing the date of the appliance's purchase, and the serial number on your appliance. At that time, you may be asked to ship your appliance, freight charges prepaid, to TRAVIS INDUSTRIES, INC. TRAVIS INDUSTRIES, INC., at its option, will repair or replace, free of charge, your TRAVIS appliance if it is found to be defective in material or workmanship within the time frame stated within this 7 year warranty. TRAVIS INDUSTRIES, INC. will return your appliance, freight charges (years 1 to 5) prepaid by TRAVIS INDUSTRIES, INC., to your regional distributor, or dealership.
- Check with your dealer in advance for any costs to you when arranging a warranty call. Mileage or service charges are not covered by this warranty. This charge can vary from store to store.

Index

Accent Light Replacement	21	Manual On-Off / Smart Thermostat / Standard Thermostat	12
Battery Replacement.....	15	Mode Controls (Flame, Blower, Accent Light, Comfort Control, AUX)	13
Before You Begin	6	Normal Operating Odors.....	16
Child-Proof Feature.....	16	Pilot Fuel Conservation Timer	10
Continuous/Intermittent Pilot Switch	9	Power Outages	16
Direct Operation	8	Remote Control Warnings	6
Display Fahrenheit or Celsius	15	Remote Operation.....	11
Ember-Glo™ Bulb Replacement.....	22	Remote Set-Up	7
Features	3	Replacement Parts List.....	26
Glass Cleaning.....	23	Starting the Heater for the First Time	8
Heating Specifications.....	3	Troubleshooting Table	24
Important Information	2	Upper Accent Lights	21
Installation Warnings.....	2	Wiring Diagram	25
Limited Warranty	27	Yearly Service Procedure	17
Location of Controls	8		
Low Battery Indicator	15		

Want to know more?

Scan this code with a QR reader on your cell phone or use the URL below to watch a video of how to use the GreenSmart® remote.



<https://vimeo.com/84052701>